

Agilent 4-Port PNA-L Microwave Network Analyzers

N5230A Options 240, 245
300 kHz to 20 GHz

Speed and accuracy
you can count on

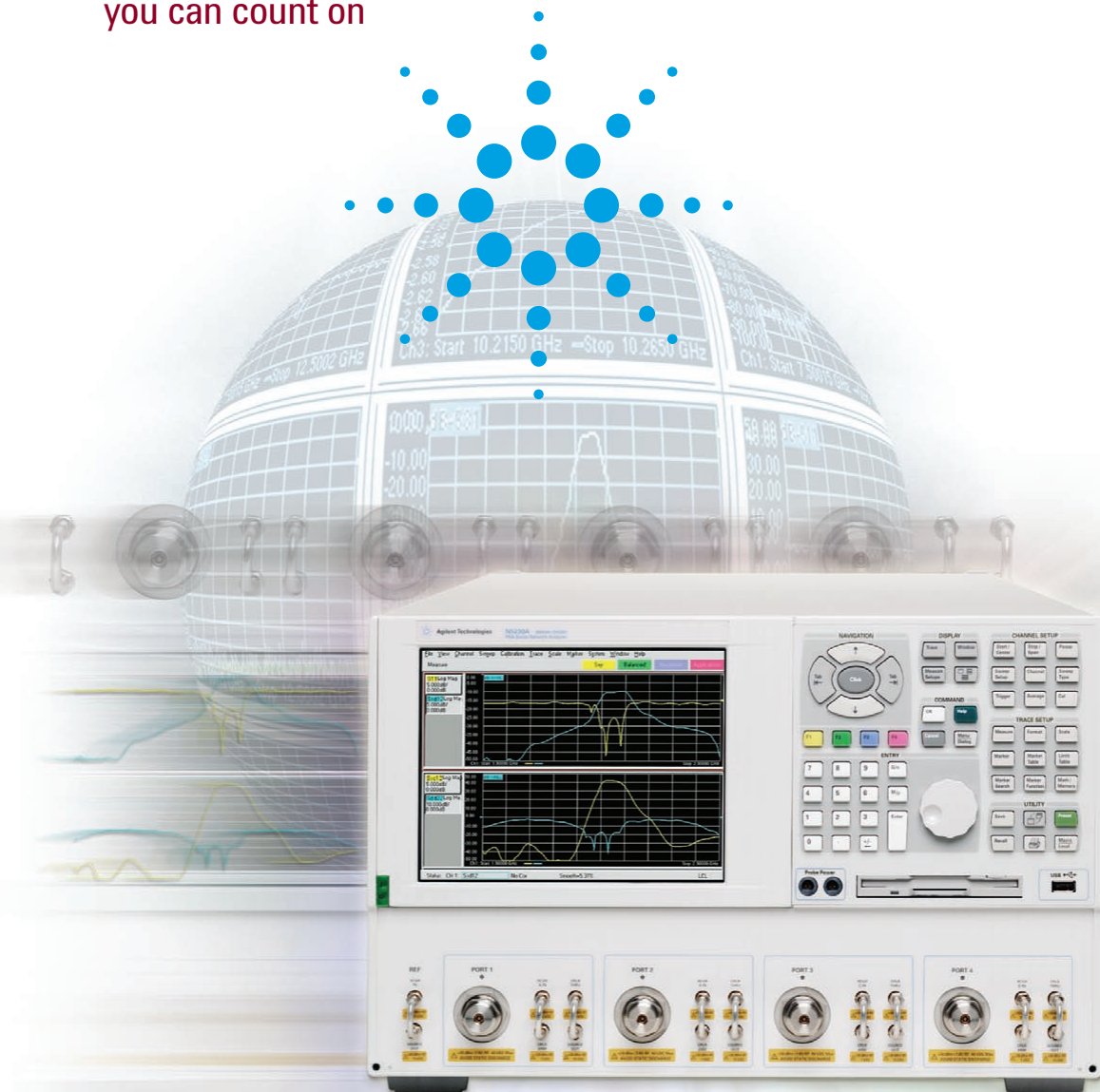

Integrated 4-port, balanced measurements up to 20 GHz

Introducing the 4-port PNA-L network analyzer



**Speed,
accuracy,
and features
for modern
component test**

Key Features

- 300 kHz to 20 GHz single-ended and balanced measurements
- High speed measurements – less than 4 μ s per point
- *Automatic port extension* feature for easy and accurate test fixture calibration
- Configurable test set for applications such as high power measurements
- Excellent dynamic range (120 dB¹) and trace noise (0.006 dB rms²)
- Exceptional accuracy with NIST³ – traceable electronic calibration (ECal) modules (optional)
- Time-domain analysis and frequency-offset measurements (optional)

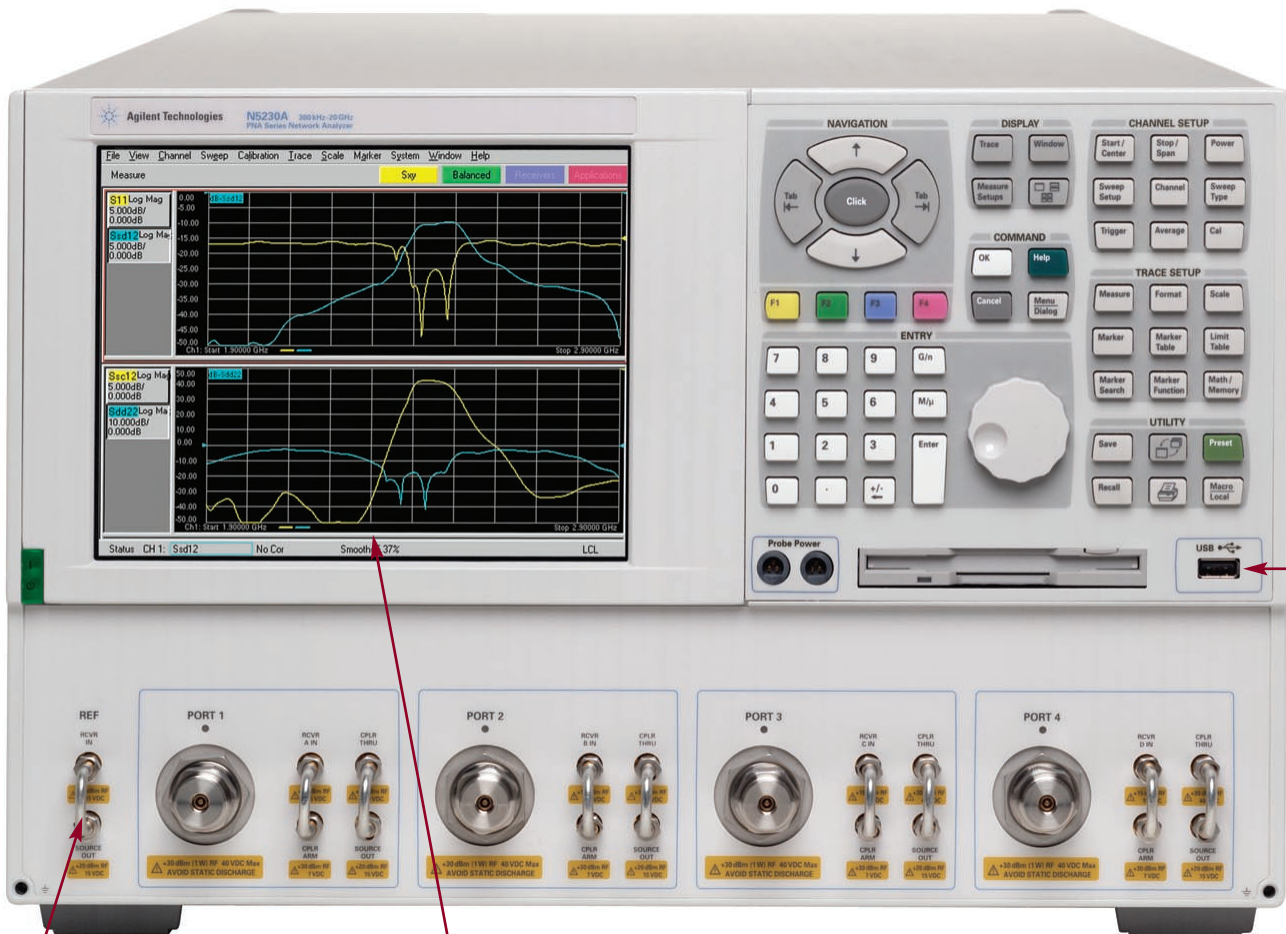

• **Configurable test set** (optional) for applications such as high power testing

• **Up to 16 windows and 32 independent measurement channels** for easy execution and viewing of complex test setups

• **2- and 4-port ECal modules** (optional) allow you to calibrate up to 30 times faster than mechanical standards-based calibration

1. At 2 GHz.
2. At 100 kHz bandwidth.
3. NIST: National Institute of Standards and Technology.

Fast measurements improve throughput and reduce the cost of test

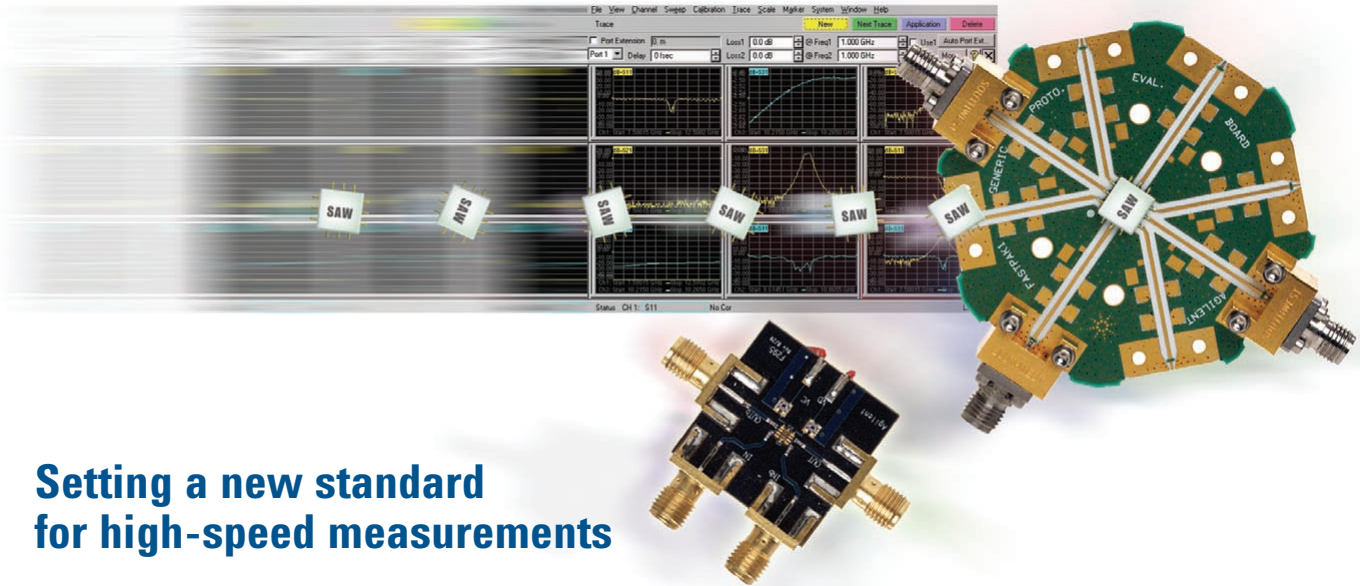

Setting a new standard for high-speed measurements

New multiport components require complicated test plans. Multiple port combinations must be tested over several frequency bands, resulting in lengthy tests.

To reduce test time and lower costs, the 4-port PNA-L has been designed for high-speed measurements. It offers IF bandwidths up to 600 kHz, and sweep speeds as low as 4 μ s/point.

To further simplify complex test requirements, up to 32 independent measurement channels are available, eliminating the need for recalling instrument states. Advanced triggering capabilities allow for easy and fast synchronization with other system components. Additionally, PNA-L's new innovative computation techniques make calculating multiple S-parameters faster than ever. When measurements are complete, results are easily saved, printed or exported to external tools for analysis or documentation via LAN or GPIB interfaces.

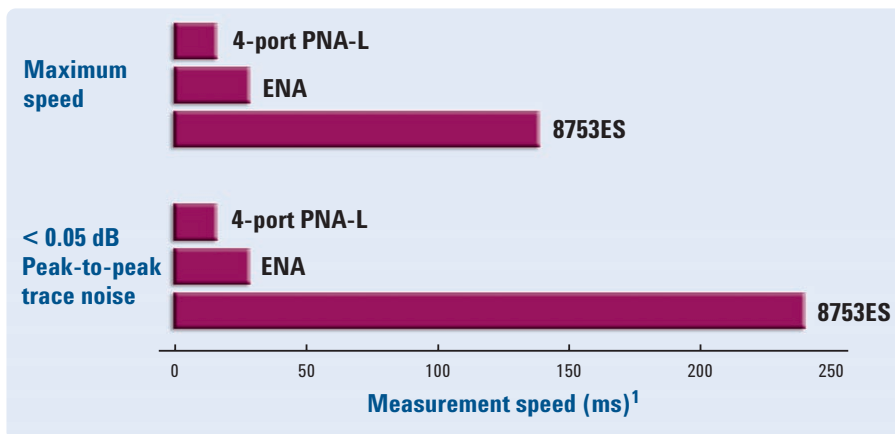

Agilent 8753ES, 4-port PNA-L, and ENA network analyzer comparisons:
The 4-port PNA-L's fast measurement speed and low trace noise can dramatically increase throughput.

1. 1 GHz CF, 100 MHz span, 201 points, 2-port cal.

Accurate, reliable 4-port measurements up to 20 GHz



The need for accurate measurements

Component designers and manufacturers are continually challenged to keep up with increasing frequencies and component complexity. Whether for wireless LAN front-end modules or satellite filters, modern component production lines require accurate as well as fast test to stay competitive.

Agilent's 4-port PNA-L network analyzer offers the industry's best combination of speed and accuracy to meet these measurement challenges. With low trace noise (0.006 dB rms at 100 kHz bandwidth) and high dynamic range (up to 120 dB at 2 GHz), the PNA-L provides engineers with greater accuracy and repeatability, minimizing measurement uncertainty.



Precise, repeatable results

Testing at microwave frequencies introduces many challenges compared to RF. Impedance mismatch errors increase, system stability decreases, and very small physical changes can significantly alter test results. Errors that were negligible at RF frequencies, now become significant and may jeopardize the integrity of your results.

The 4-port PNA-L was designed to provide consistent, repeatable results over its entire frequency range. A new RF hardware design offers superb resistance to drift over time and during temperature changes.

Trace noise has also been reduced to exceptionally low levels, as illustrated below. Even at the full IF bandwidth of 600 kHz, trace noise is typically less than 0.013 dB rms¹, providing stable measurement results with low uncertainty.

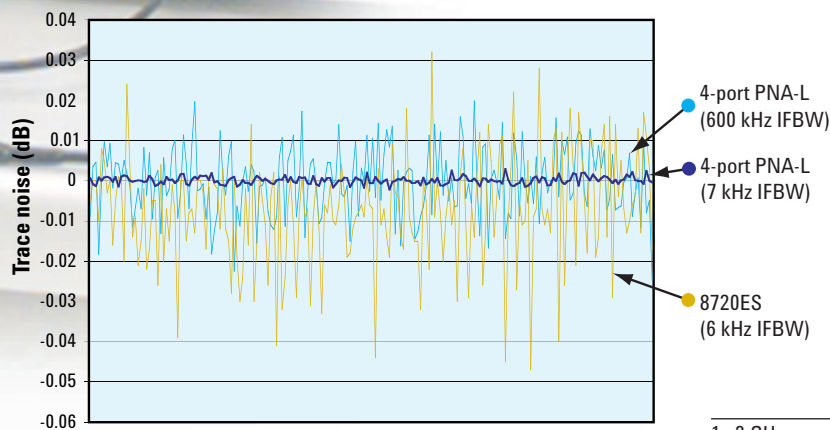

Agilent 20 GHz 8720ES and PNA-L network analyzer comparison:²
The 4-port PNA-L offers superb trace noise.

1. 2 GHz measurement frequency, -5 dBm output power.
2. S11 measurement of a short, 950 to 1000 MHz, 201 points, -5 dBm.

Precise calibrations provide confidence

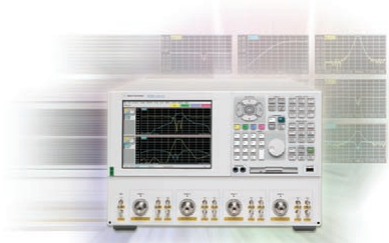

Removing calibration complexity

Calibration is crucial for accurate measurements. Agilent offers a variety of NIST-traceable electronic calibration (ECal) modules to speed your calibration process. With ECal modules, you can perform fast, repeatable calibrations that are as accurate as a sliding load mechanical calibration, but less error-prone and more than 30 times faster.

Two-port ECal modules operating from 300 kHz to beyond 20 GHz offer fast and accurate calibration. The PNA-L calibration software allows you to make a full 4-port calibration using a 2-port ECal module with only 4 connections and disconnections (the same as a 4-port module).

For even more convenience and time savings, 4-port ECal modules offer one-step calibrations from 300 kHz to 13.5 GHz, satisfying the requirements of a wide variety of applications such as GSM component test.

In-fixture measurements

Normal coaxial calibrations do not account for the effects of fixtures on measurements, and resulting errors can become quite significant at microwave frequencies. The 4-port PNA-L offers a variety of easy and accurate methods to correct for fixtures.

Port extensions

Traditional port extensions allow the user to enter an electrical delay, correcting for the physical length of the test fixture. As test frequencies increase beyond a few GHz, however, the insertion loss of a fixture becomes significant as well. The 4-port PNA-L port extension feature allows a user to input an insertion loss value in addition to electrical delay, allowing for much more accurate fixture compensation.

To further simplify fixture compensation, Agilent introduces the innovative Automatic Port Extensions feature. With this one-button feature, the 4-port PNA-L automatically measures a fixture's electrical length and insertion loss and applies the correction to measurements, making in-fixture measurements easy and accurate.

Embedding and de-embedding

The 4-port PNA-L offers full embedding and de-embedding of user-supplied S-parameter data files, as well as predefined matching circuit topologies that can be mathematically embedded. Port impedance conversion is available for testing devices that are not 50 ohms.



ECal enables fast, accurate, repeatable calibrations 30 times faster than mechanical calibration.

Advanced features for R&D and manufacturing

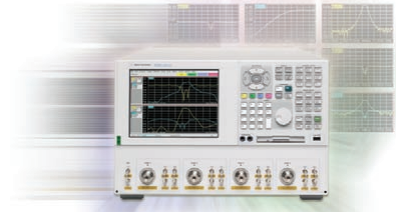

Built to improve your efficiency

The 4-port PNA-L makes it simple to measure a variety of devices. Easily measure single-ended, balanced, and mixed mode S-parameters in addition to ratioed and unratioed receiver measurements.

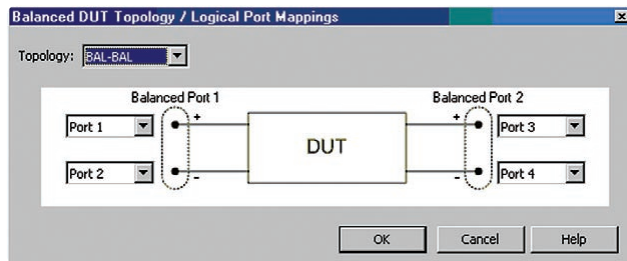

Graphical interface makes it easy to set up balanced measurements.

The 4-port PNA-L is supported by Agilent's Advanced Design System (ADS). The ADS Connection Manager effortlessly connects to the PNA-L, enabling device data to be used in circuit and system simulation. Users can also save 4-port data as ".s4p" files, which are easily imported into ADS for analysis.

Analysis features such as trace statistics and trace math provide insight into device behavior, while mixed-mode measurements such as common-to-differential mode conversion allow you to discover design flaws early in the design process.

Use Agilent's Physical Layer Test System (PLTS) software to expand the 4-port PNA-L's measurement capabilities for high-speed differential interconnect design and validation.¹ PLTS software combines frequency-domain, time-domain, and eye-diagram analysis to provide a comprehensive view of your physical layer element. It also controls measurement setup and calibration to provide the most accurate measurements for model extraction, characterization, and validation of your designs.

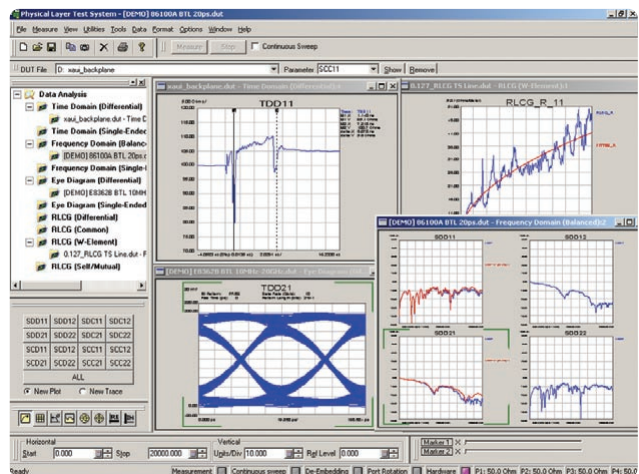

Characterize and validate differential channels with a full suite of analysis tools available in PLTS.

The 4-port PNA-L can even be used to improve manufacturing throughput when testing 2-port devices. Use the four integrated ports to simultaneously test multiple devices, or test one device while connecting or disconnecting another.

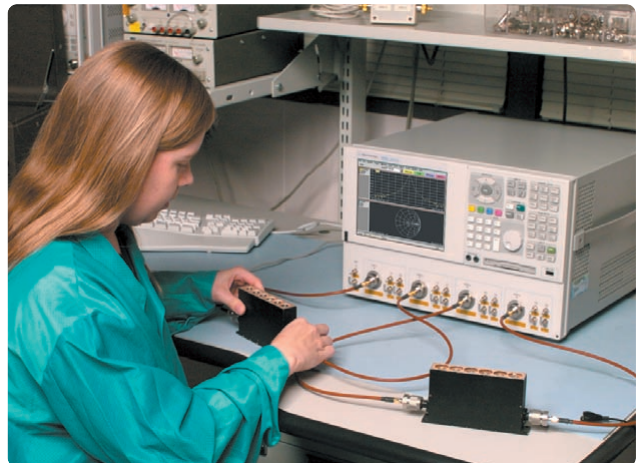

Use all 4 ports to eliminate connect/disconnect inefficiencies.

1. PLTS support of 4-port PNA-L available early 2005.

Agilent offers a comprehensive portfolio of 4-port solutions



Choose the solution that's right for you

Agilent's ENA and PNA-L network analyzers and Physical Layer Test Systems (PLTS) provide a variety of 4-port and balanced measurement solutions from 300 kHz to 50 GHz to meet your specific application and budget needs.

Since all of these products use common calibration and measurement algorithms, you can be sure no matter which Agilent solution you use, you will get the right answer every time.

Select a specific frequency range that suits your application needs...

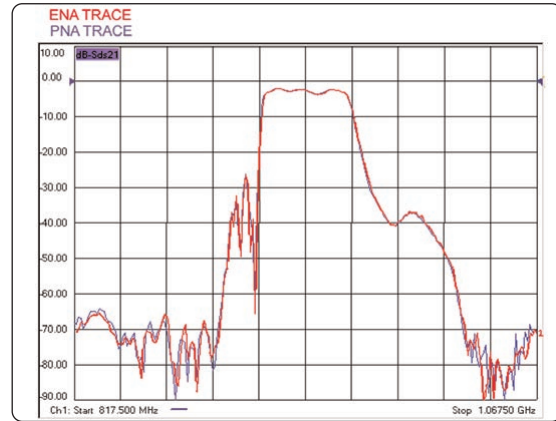

Get consistent results with the ENA and PNA-L network analyzers.

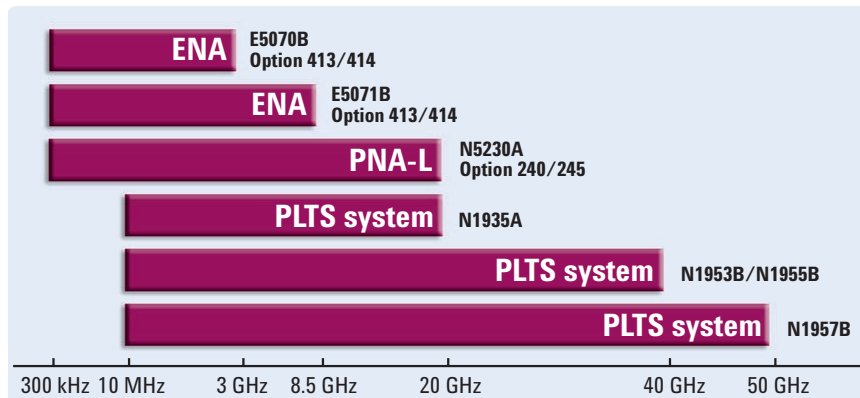

Specification summary

	4-port ENA RF network analyzers	4-port PNA-L network analyzers	Physical Layer Test Systems (PLTS)
Maximum frequency	8.5 GHz	20 GHz	50 GHz
Measurement speed	9.6 μ s/point	4 μ s/point	26 μ s/point
Embedding/de-embedding	Port extensions	Port extensions	Port extensions
	—	Auto port extension	—
	Impedance conversion	Impedance conversion	Impedance conversion
	Defined circuit embed	Defined circuit embed	—
Dynamic range (2, 20 GHz)	S-parameter file embed/de-embed	S-parameter file embed/de-embed	S-parameter file embed/de-embed
	122 dB, n/a	120 dB, 103 dB	Depends on system configuration
Maximum power (2, 20 GHz)	+10 dBm, n/a	+8 dBm, -3 dBm	Depends on system configuration
Frequency-offset measurements	Frequency-offset mode option	Frequency-offset mode option	—
Calibration	SOLT, TRL, LRM	SOLT	SOLT, TRL, LRM
Configurable test set	—	Yes	Yes

Note: Agilent also offers high-performance 2-port PNA network analyzers. For more information, visit www.agilent.com/find/pna
For more information about PLTS, go to www.agilent.com/find/PLTS

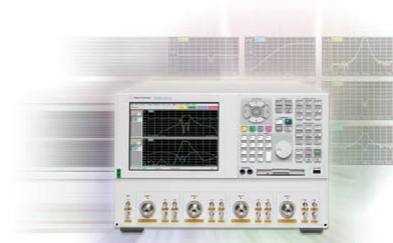

PNA-L option descriptions

Test set options

- **Standard test set and power range – Option 240**
- **Configurable test set and extended power range – Option 245**
 Adds nine front panel access loops and a 60 dB step attenuator as shown in the figure below. This provides the capability to add external components for high power measurements, improve instrument sensitivity for measuring low-level signals, or to add other peripheral instruments for a variety of measurement applications.

Standard test set

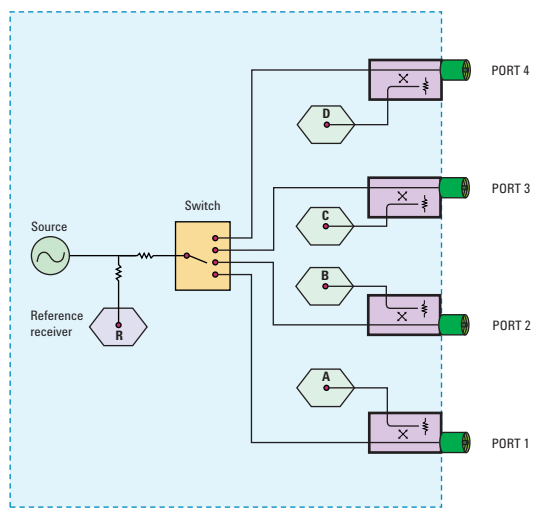

Configurable test set and extended power range

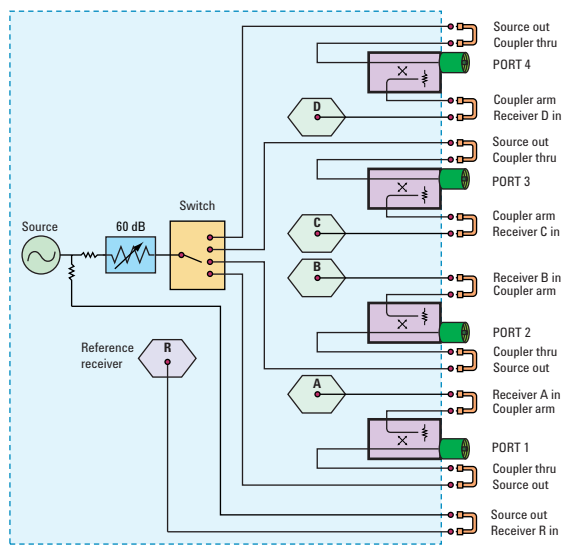

Additional options

Time domain – Option 010

This option enables the PNA Series to view reflection and transmission responses in both time or distance domain. Use time domain to tune filters, gate out the response of fixtures and cables, characterize the impedance of transmission line, and more.

Frequency offset – Option 080

This option enables the PNA Series to set the source frequency independently from where the receivers are tuned. This ability is important for two general classes of devices: mixers (converters) and amplifiers.

Certification options

Commercial calibration certification with test data – Option UK6

Complete set of measurements which tests unit to manufacturer's published specifications. Includes calibration label, calibration certificate, and data report. Conforms to ISO 9001.

ISO 17025 compliant calibration – Option 1A7

Complete set of measurements which tests unit to manufacturer's published specifications. Includes ISO 17025 compliant calibration certificate, label and seals, a full measurement uncertainty report, and a statement of specification compliance. Conforms to ISO 17025 and ISO 9001.

Agilent also offers a variety of 2-port PNA-L solutions for frequency ranges up to 20, 40, or 50 GHz.
 For more information visit:
www.agilent.com/find/pnal

Configuration and ordering information

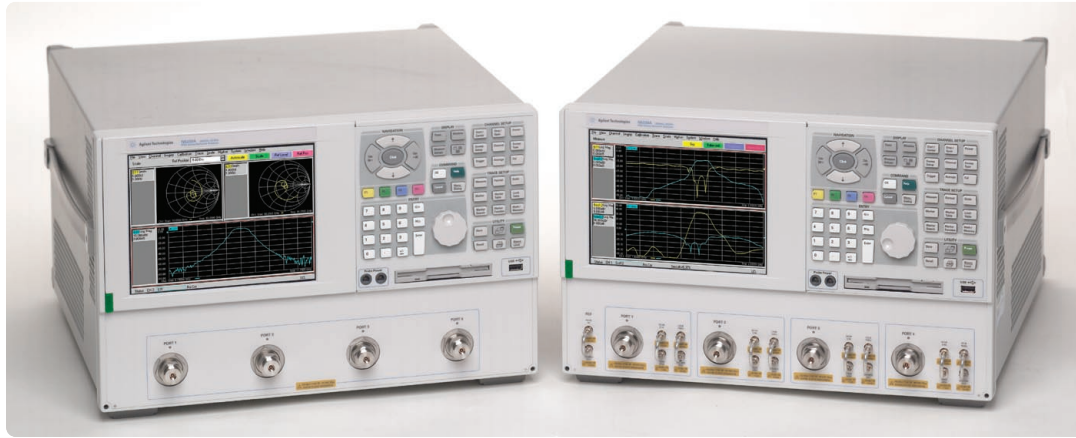

Step 1: Select N5230A model number

Step 2: Choose your test set (mandatory, choose only one)

Description	Ordering number
300 kHz to 20 GHz Standard 4-port test set	N52300-240
300 kHz to 20 GHz Configurable 4-port test set and extended power range	N52300-245

Step 3: Choose additional software options (optional)

Description	Ordering number
Time domain	N52300-010
Frequency-offset measurement	N52300-080

Step 4: Choose an electronic or mechanical calibration kit (optional, recommended)

Description	Ordering number
300 kHz to 26.5 GHz, 2-port ECal module 3.5 mm connectors	N4691B ¹
300 kHz to 18 GHz, 2-port ECal module N-type connectors	N4690B
300 kHz to 13.5 GHz, 4-port ECal module 3.5 mm or N-type connectors	N4431B

For additional options, refer to the Agilent PNA Series Configuration Guide (5988-7989EN) available on our Web site: www.agilent.com/find/pna

Step 5: Accessories (Optional)

Description	Ordering number
Physical layer test system (PLTS) software	N1930A
Node-locked license	N1930A-010
Server-based/floating license	N1930A-020
Rack mount kit without handle	N5230A-1CM
Rack mount kit with handles	N5230A-1CP
USB CD R/W drive	N4688A
USB hub	N4689A

Step 6: Calibration documentation (optional)

Description	Ordering number
ISO 17025 compliant calibration	N5230A-1A7
Commercial calibration certificate with test data	N5230A-UK6

Step 7: Choose your warranty and service plan (optional) (standard warranty is 1 year)

Description
1 year return-to-Agilent warranty and service
3 year return-to-Agilent warranty and service
5 year return-to-Agilent warranty and service

Documentation

PNA-L instruments are equipped with an embedded Help system available within the instrument in the following languages: English, Japanese, Chinese, German, Spanish, and French. The PNA Service Guide and embedded Help system are available on the Web: www.na.tm.agilent.com/pna

Additional ordering information

For detailed information regarding additional measurement accessories and options for the PNA Series, refer to the Agilent PNA Series Configuration Guide available on our Web site: www.agilent.com/find/pnal

1. Available November 2004.

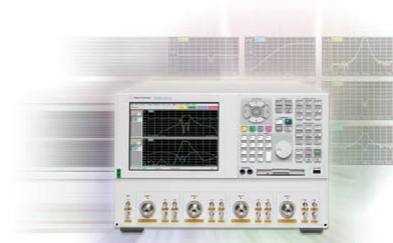

Key specifications

Note: For the most current and complete specifications, please refer to the PNA-L Data Sheet available in the "Key Library" section of the PNA-L Web site: www.agilent.com/find/pnal

Some definitions

Specification (spec.): Warranted performance. Specifications include guardbands to account for the expected statistical performance distribution, measurement uncertainties, and changes in performance due to environmental conditions.

Typical (typ.): Expected performance of an average unit, which does not include guardbands. It is not covered by the product warranty.

System dynamic range^{1, 4}

Description	Specification at test port		Specification at direct receiver access input ²	
	Option 240	Option 245	Option 240	Option 245
Dynamic range (10 Hz IF BW)				
300 kHz to 10 MHz	(111 dB typ.)	(111 dB typ.)	N/A	(127 dB typ.)
10 MHz to 4 GHz	120 dB (128 dB typ.)	120 dB (128 dB typ.)	N/A	136 dB
4 GHz to 6 GHz	118 dB (129 dB typ.)	118 dB (128 dB typ.)	N/A	134 dB
6 GHz to 10.5 GHz	115 dB (127 dB typ.)	113 dB (125 dB typ.)	N/A	129 dB
10.5 GHz to 15 GHz	107 dB (119 dB typ.)	105 dB (117 dB typ.)	N/A	121 dB
15 GHz to 20 GHz	103 dB (116 dB typ.)	98 dB (115 dB typ.)	N/A	114 dB

Test port output ³	Option 240	Option 245
Max leveled power		
300 kHz to 10 MHz	+8 dBm (typ.)	+8 dBm (typ.)
10 MHz to 4 GHz	+8 dBm	+8 dBm
4 GHz to 6 GHz	+6 dBm	+6 dBm
6 GHz to 10.5 GHz	+3 dBm	+1 dBm
10.5 GHz to 15 GHz	0 dBm	-2 dBm
15 GHz to 20 GHz	-3 dBm	-8 dBm
Power range (typ.)		
300 kHz to 10 MHz	-27 to +8 dBm	-87 to +8 dBm
10 MHz to 4 GHz	-27 to +12 dBm	-87 to +11 dBm
4 GHz to 6 GHz	-27 to +10 dBm	-87 to +9 dBm
6 GHz to 10.5 GHz	-27 to +8 dBm	-87 to +6 dBm
10.5 GHz to 15 GHz	-27 to +5 dBm	-87 to +3 dBm
15 GHz to 20 GHz	-27 to +2 dBm	-87 to -1 dBm
Power sweep range		
300 kHz to 10 MHz	35 dB (typ.)	35 dB (typ.)
10 MHz to 4 GHz	33 dB	33 dB
4 GHz to 6 GHz	31 dB	31 dB
6 GHz to 10.5 GHz	28 dB	26 dB
10.5 GHz to 15 GHz	25 dB	23 dB
15 GHz to 20 GHz	22 dB	17 dB

Test port input	Option 240	Option 245
Test port noise floor⁴ (10 Hz IF bandwidth)		
300 kHz to 10 MHz	< -103 dBm (typ.)	< -103 dBm (typ.)
10 MHz to 500 MHz	< -112 dBm	< -112 dBm
500 MHz to 4 GHz	< -112 dBm	< -112 dBm
4 GHz to 10.5 GHz	< -112 dBm	< -112 dBm
10.5 GHz to 15 GHz	< -107 dBm	< -107 dBm
15 GHz to 20 GHz	< -106 dBm	< -106 dBm
Direct receiver access input noise floor⁴ (10 Hz IF bandwidth)		
300 kHz to 10 MHz	N/A	< -119 dBm
10 MHz to 500 MHz	N/A	< -128 dBm
500 MHz to 4 GHz	N/A	< -128 dBm
4 GHz to 10.5 GHz	N/A	< -128 dBm
10.5 GHz to 15 GHz	N/A	< -123 dBm
15 GHz to 20 GHz	N/A	< -122 dBm
Compression level (300 kHz to 10 MHz at +5 dBm, 10 MHz to 50 MHz at +8 dBm, 50 MHz to 20 GHz at +10 dBm)		
300 kHz to 10 MHz	0.1 dB	0.1 dB
10 MHz to 50 MHz	0.2 dB	0.2 dB
50 MHz to 1 GHz	0.4 dB	0.4 dB
1 GHz to 8 GHz	0.3 dB	0.3 dB
8 GHz to 12.5 GHz	0.4 dB	0.4 dB
12.5 GHz to 20 GHz	0.5 dB	0.5 dB

1. The system dynamic range is calculated as the difference between the noise floor and the source maximum output power, and is measured with a 10 Hz IF bandwidth, no averaging applied to data, and an isolation calibration with averaging factor of 8.
2. The direct receiver access input system dynamic range is calculated as the difference between the direct receiver access input noise floor and the source maximum output power.
3. Performance specified on port 1 only; port 2, 3, and 4 performance is a characteristic.
4. Total average (rms) noise power calculated as mean value of a linear magnitude trace expressed in dBm.



	Option 240	Option 245
Trace noise magnitude (100 kHz IFBW, ratioed measurement, nominal power at test port)(typ.)		
300 kHz to 10 MHz	0.015 dB rms	0.030 dB rms
10 MHz to 10.5 GHz	0.006 dB rms	0.008 dB rms
10.5 GHz to 20 GHz	0.010 dB rms	0.014 dB rms
Trace noise magnitude (100 kHz IFBW, ratioed measurement, maximum specified power at test port)(typ.)		
300 kHz to 10 MHz	0.005 dB rms	0.010 dB rms
10 MHz to 2 GHz	0.001 dB rms	0.003 dB rms
2 GHz to 10.5 GHz	0.002 dB rms	0.003 dB rms
10.5 GHz to 20 GHz	0.006 dB rms	0.009 dB rms

Measurement throughput (typ.): Cycle time vs. selected IFBW
Preset configuration, 201 points, CF = 10 GHz, span = 100 MHz, correction = OFF, display = OFF, maximum specified power

IFBW (Hz)	Cycle time(ms)	Trace noise (dB rms)
600000	8	0.004
360000	8	0.003
280000	8	0.002
200000	8	0.002
150000	8	0.002
100000	8	0.001
70000	8	0.001
50000	9	<0.001
30000	11	<0.001
20000	15	<0.001
15000	18	<0.001
10000	29	<0.001
7000	37	<0.001
5000	49	<0.001
3000	73	<0.001
1000	219	<0.001
700	294	<0.001
500	400	<0.001
300	636	<0.001
100	1827	<0.001
10	17904	<0.001

Damage input level

Option 240, 245	
Test port 1, 2, 3, 4	+27 dBm or ± 16 V DC (typ.)
Option 245 only	
Source out (ref)	+20 dBm or ± 16 V DC (typ.)
Source out (test ports)	+27 dBm or ± 16 V DC (typ.)
Receiver R, A, B, C, D in	+15 dBm or ± 16 V DC (typ.)
Coupler thru	+27 dBm or ± 16 V DC (typ.)
Coupler arm	+15 dBm or ± 0 V DC (typ.)

Measurement throughput (typ.): Cycle time vs. number of points
Preset configuration, CF = 10 GHz, span = 100 MHz, correction = OFF, display = OFF

IFBW (Hz)	Number of points	Cycle time (ms)
600000	11	6.6
600000	51	6.8
600000	101	6.9
600000	201	7.3
600000	401	8.1
600000	801	9.4
600000	1601	12.0
600000	16001	59.3
100000	11	6.6
100000	51	6.8
100000	101	7.0
100000	201	7.5
100000	401	9.0
100000	801	13.5
100000	1601	22.9
100000	16001	180.3



Web Resources

Visit our Web sites for additional product information and literature.

PNA-L Microwave network analyzers
www.agilent.com/find/pnal

PNA Microwave network analyzers
www.agilent.com/find/pna

ENA RF network analyzers
www.agilent.com/find/ena

Physical layer test systems
www.agilent.com/find/plts

Electronic calibration (ECal) modules
www.agilent.com/find/ecal

RF and microwave accessories
www.agilent.com/find/accessories



Agilent Email Updates

www.agilent.com/find/emailupdates
Get the latest information on the products and applications you select.

Windows® and Visual Basic® are U.S. registered trademark of Microsoft Corporation.

Agilent Technologies' Test and Measurement Support, Services, and Assistance

Agilent Technologies aims to maximize the value you receive, while minimizing your risk and problems. We strive to ensure that you get the test and measurement capabilities you paid for and obtain the support you need. Our extensive support resources and services can help you choose the right Agilent products for your applications and apply them successfully. Every instrument and system we sell has a global warranty. Support is available for at least five years beyond the production life of the product. Two concepts underlie Agilent's overall support policy: "Our Promise" and "Your Advantage."

Our Promise

Our Promise means your Agilent test and measurement equipment will meet its advertised performance and functionality. When you are choosing new equipment, we will help you with product information, including realistic performance specifications and practical recommendations from experienced test engineers. When you receive your new Agilent equipment, we can help verify that it works properly and help with initial product operation.

Your Advantage

Your Advantage means that Agilent offers a wide range of additional expert test and measurement services, which you can purchase according to your unique technical and business needs. Solve problems efficiently and gain a competitive edge by contracting with us for calibration, extra-cost upgrades, out-of-warranty repairs, and onsite education and training, as well as design, system integration, project management, and other professional engineering services. Experienced Agilent engineers and technicians worldwide can help you maximize your productivity, optimize the return on investment of your Agilent instruments and systems, and obtain dependable measurement accuracy for the life of those products.

Agilent T&M Software and Connectivity

Agilent's Test and Measurement software and connectivity products, solutions and developer network allows you to take time out of connecting your instruments to your computer with tools based on PC standards, so you can focus on your tasks, not on your connections. Visit www.agilent.com/find/connectivity for more information.

For more information on Agilent Technologies' products, applications or services, please contact your local Agilent office. The complete list is available at:

www.agilent.com/find/contactus

Phone or Fax

United States:

(tel) 800 829 4444
(fax) 800 829 4433

Canada:

(tel) 877 894 4414
(fax) 800 746 4866

China:

(tel) 800 810 0189
(fax) 800 820 2816

Europe:

(tel) 31 20 547 2111

Japan:

(tel) (81) 426 56 7832
(fax) (81) 426 56 7840

Korea:

(tel) (080) 769 0800
(fax) (080)769 0900

Latin America:

(tel) (305) 269 7500

Taiwan:

(tel) 0800 047 866
(fax) 0800 286 331

Other Asia Pacific

Countries:

(tel) (65) 6375 8100
(fax) (65) 6755 0042

Email: tm_ap@agilent.com

Contacts revised: 9/17/04

Product specifications and descriptions in this document subject to change without notice.

© Agilent Technologies, Inc. 2003, 2004
Printed in USA, September 30, 2004
5989-0896EN



Agilent Technologies